

Panel Mount SMPS



SPA Series PRODUCT MANUAL

For your safety, read and follow the considerations written in the instruction manual, other manuals and Autonics website.

The specifications, dimensions, etc. are subject to change without notice for product improvement. Some models may be discontinued without notice.

Major Features

- Stable power supply with minimal noise and ripple
- Built-in overcurrent protection circuit, output short-circuit protection circuit, overheat protection circuit, and overvoltage protection circuits (overvoltage protection: SPA-075/100 only)
- EN 60950 (Safety of information technology equipment) compliant
- EN 50178 (Electronic equipment for use in power installations) compliant
- EN 61000-6-2 (EMC: Immunity for industrial environments) compliant
- EN 61000-6-4 (EMC: Emission standard for industrial environments) compliant
- Output voltage: 5VDC $\overline{\text{=}}$, 12VDC $\overline{\text{=}}$, 24VDC $\overline{\text{=}}$
- Output power: 30 W, 50 W, 75 W, 100 W

Safety Considerations

- Observe all 'Safety Considerations' for safe and proper operation to avoid hazards.
- Δ symbol indicates caution due to special circumstances in which hazards may occur.

Δ Warning Failure to follow instructions may result in serious injury or death.

- 01. Fail-safe device must be installed when using the unit with machinery that may cause serious injury or substantial economic loss. (e.g. nuclear power control, medical equipment, ships, vehicles, railways, aircraft, combustion apparatus, safety equipment, crime/disaster prevention devices, etc.)**
Failure to follow this instruction may result in personal injury, economic loss or fire.
- 02. Do not use the unit in the place where flammable/explosive/corrosive gas, high humidity, direct sunlight, radiant heat, vibration, impact, or salinity may be present.**
Failure to follow this instruction may result in explosion or fire.
- 03. Install on the device panel, and ground to the F.G. terminal separately.**
Failure to follow this instruction may result in fire or electric shock.
- 04. Do not connect, repair, or inspect the unit while connected to a power source.**
Failure to follow this instruction may result in fire or electric shock.
- 05. Check 'Wiring Diagram' before wiring.**
Failure to follow this instruction may result in fire.
- 06. Do not disassemble or modify the unit.**
Failure to follow this instruction may result in fire or electric shock.

Δ Caution Failure to follow instructions may result in injury or product damage.

- 01. When connecting the F.G. terminal, use AWG 14 (2.1 mm²) cable or over and tighten the terminal screw with a tightening torque of 0.7 to 0.9 N·m.**
Failure to follow this instruction may result in fire or malfunction due to contact failure.
- 02. Use the unit within the rated specifications.**
Failure to follow this instruction may result in fire, product damage or shortening the life cycle of the product.
- 03. Use dry cloth to clean the unit, and do not use water or organic solvent.**
Failure to follow this instruction may result in electric shock or fire.
- 04. Keep the product away from metal chip, dust, and wire residue which flow into the unit.**
Failure to follow this instruction may result in fire or product damage.
- 05. Do not touch the product during operation or for a certain period of time after stopping.**
Failure to follow this instruction may result in burns.
- 06. Upon occurrence of an error, disconnect the power source.**
Failure to follow this instruction may result in fire or product damage.

Cautions during Use

- Follow instructions in 'Cautions during Use'.
Otherwise, it may cause unexpected accidents.
- Do not connect the output voltage neither in serial nor in parallel.
- Since there is no harmonic suppression or power factor correction circuit, install the circuit separately if necessary.
- Since using the condenser input method, power factor is in the range of 0.4 to 0.6.
When using distribution board or transformer, check the capacity of the input voltage.
Input apparent power (VA) = $\frac{\text{Output active power (W)}}{\text{Power factor} \times \text{Efficiency}}$
- Even though a noise filter is installed inside the product, the product can be affected by noise depending on the installation location or wiring.
- If the internal fuse is damaged, please contact our A/S center.
- To ensure the reliability of the product, install the product vertically on the panel or metal surface.

- Install the unit in the well ventilated place.
- Do not use near the equipment which generates strong magnetic force or high frequency noise.
- In case of models using the user switching method for the input voltage selection, factory default is set to 220 V. When switching over to 110 V, remove the case of the product as below and select the voltage with the jumper switch within the range of the input voltage.

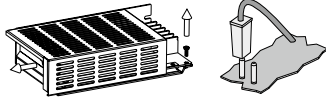

- This unit may be used in the following environments.
 - Indoors (in the environment condition rated in 'Specifications')
 - Altitude max. 2,000 m
 - Pollution degree 2
 - Installation category II

Ordering Information

This is only for reference, the actual product does not support all combinations. For selecting the specific model, follow the Autonics web site.

SPA - ① - ②

① Output power

Number: Output power (unit: W)

② Output voltage

Number: Output voltage (unit: VDC)

Product Components

- Product
- Instruction manual

Specifications

Output range	30 to 50 W					
Model	SPA-030-05	SPA-050-05	SPA-030-12	SPA-050-12	SPA-030-24	SPA-050-24
Output power	30 W	50 W	30 W	50 W	30 W	50 W
Input condition						
Voltage ⁽¹⁾	100 - 240 VAC~					
Permissible voltage range	85 - 264 VAC~					
Frequency	50 / 60 Hz					
Efficiency ⁽²⁾ (typical)	≥ 60 %	≥ 67 %	≥ 74 %	≥ 74 %	≥ 80 %	≥ 80 %
Current consumption ⁽²⁾ (typical)	≤ 1.2 A	≤ 1.6 A	≤ 1.0 A	≤ 1.4 A	≤ 0.8 A	≤ 1.1 A
Inrush current protection (typical)	100 VAC~ ≤ 30 A	≤ 40 A	≤ 20 A	≤ 20 A	≤ 20 A	≤ 20 A
240 VAC~	≤ 40 A	-	-	-	-	-
Output characteristics						
Voltage	5 VDC≡		12 VDC≡		24 VDC≡	
Current	6 A	10 A	2.5 A	4.2 A	1.5 A	2.1 A
Voltage adjustment range ⁽³⁾	≤ ± 5 %					
Input variation ⁽⁴⁾	≤ ± 0.5 %					
Load variation ⁽²⁾	≤ ± 2 %					
Ripple noise ⁽²⁾	≤ ± 1 %					
Start-up time ⁽²⁾ (typical)	≤ 200 ms					
Hold time ⁽²⁾ (typical)	≥ 10 ms					
Protection						
Over-current protection ⁽⁵⁾	≥ 110 %					
Over-voltage protection ⁽³⁾	-					
Output short-circuit protection	≤ 5 ms					
Certification	CE UK		CE UK		CE UK	
Unit weight	≈ 350 g		≈ 350 g		≈ 350 g	

Output range	75 to 100 W					
Model	SPA-075-05	SPA-100-05	SPA-075-12	SPA-100-12	SPA-075-24	SPA-100-24
Output power	75 W	100 W	75 W	100 W	75 W	100 W
Input condition						
Voltage ⁽¹⁾	100 - 120 / 200 - 240 VAC~ (permissible voltage: 85 - 264 VAC~) switching type					
Frequency	50 / 60 Hz					
Efficiency ⁽²⁾ (typical)	≥ 70 %	≥ 78 %	≥ 78 %	≥ 72 %	≥ 78 %	≥ 80 %
Current consumption ⁽²⁾ (typical)	≤ 3.0 A	≤ 2.0 A	≤ 3.0 A	≤ 3.0 A	≤ 2.0 A	≤ 2.5 A
Inrush current protection (typical)	100 VAC~ ≤ 45 A	≤ 50 A	≤ 35 A	≤ 45 A	≤ 35 A	≤ 40 A
240 VAC~	≤ 50 A	≤ 40 A	≤ 40 A	≤ 50 A	≤ 40 A	≤ 40 A
Output characteristics						
Voltage	5 VDC≡		12 VDC≡		24 VDC≡	
Current	15 A	20 A	6.3 A	8.5 A	3.2 A	4.2 A
Voltage adjustment range ⁽³⁾	≤ ± 5 %					
Input variation ⁽⁴⁾	≤ ± 0.5 %					
Load variation ⁽²⁾	≤ ± 2 %					
Ripple noise ⁽²⁾	≤ ± 1 %					
Start-up time ⁽²⁾ (typical)	≤ 250 ms					
Hold time ⁽²⁾ (typical)	≥ 5 ms					
Protection						
Over-current protection ⁽⁵⁾	≥ 110 %		≥ 105 %		≥ 110 %	
Over-voltage protection ⁽³⁾	6.5 V ± 10 %		16.0 V ± 10 %		30.0 V ± 10 %	
Output short-circuit protection	≤ 10 ms		≤ 5 ms		≤ 10 ms	
Certification	CE UK		CE UK		CE UK	
Unit weight	≈ 400 g		≈ 400 g		≈ 400 g	

Indicator	Output indicator (green)
Insulation resistance	Between all inputs and outputs: ≥ 100 MΩ (500 VDC≡ megger)
Dielectric strength	Between all inputs and outputs: 3,000 VAC~ 50/60 Hz for 1 min Between the charging part and the F.G.: 1,500 VAC~ 50/60 Hz for 1 min
Vibration	10 to 55 Hz amplitude at frequency 0.75 mm in each X, Y, Z direction for 2 hours
Shock	300 m/s ² (≈ 30 G) in each X, Y, Z direction for 3 times
EMS	EN61000-6-2 conformation
EMI	EN61000-6-4 conformation
Safety standards	EN60950, EN50178
Ambient temperature	-10 to 50 °C (SPA-050-05, SPA-030-12, SPA-050-12: -10 to 40 °C), storage: -25 to 65 °C (no freezing or condensation)
Ambient humidity	25 to 85 %RH, storage: 25 to 90 %RH (no freezing or condensation)

- 01) Since there is no separate input over-voltage protection for the voltage over the rated input voltage range, Supplying over-voltage may result in product damage.
- 02) It is in the rated input voltage 100 VAC~ with 100 % load.
- 03) Use the output voltage adjusting volume within the voltage variable range. If the voltage exceeds the output voltage range, overvoltage protection function is activated and the output is cut off.
- 04) Rate input voltage
 - SPA-030 / 050 series: 100 - 240 VAC~ (85 - 264 VAC~) with 100 % of load
 - SPA-075 / 100 series: 100 - 120 / 200 - 240 (85 - 132 / 170 - 264 VAC~) with 100 % of load
 - SPA-100-05 model: 100 - 120 / 200 - 240 VAC~ (100 - 132 / 190 - 264 VAC~) with 100 % of load
- 05) It is for rate input voltage 100 VAC~.

Dimensions

- Unit: mm, refer to the Autonics website for the details of the product.

■ SPA-030 / 050 series

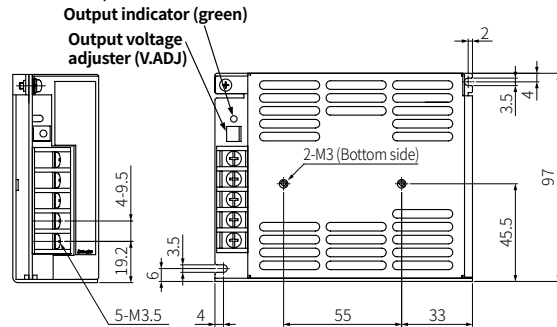

■ SPA-075 / 100 series

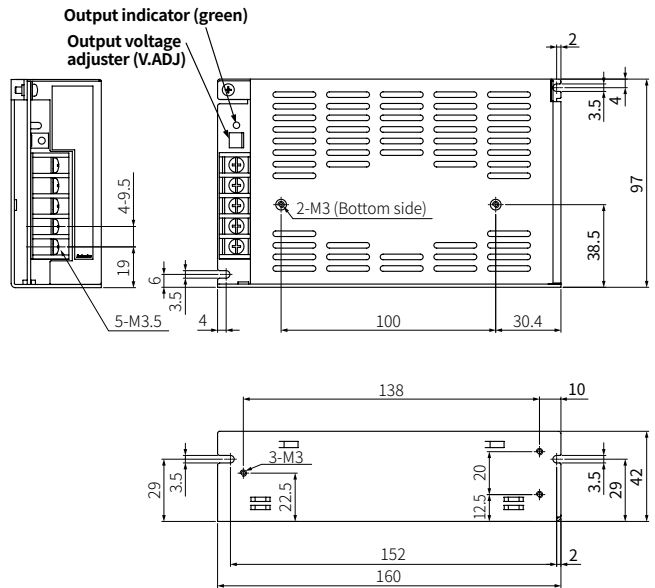

Connections

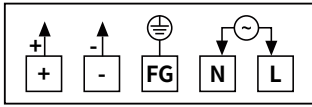

Mark	Function
+24V	Output power (+)
GND	Output power (-)
FG	Frame ground
N, L	Input power

Wire	Tightening torque	Model (SPA-□-□)
AWG 21 to 19	0.7 to 0.9 N·m	030-05, 030-12, 030-24, 050-12, 050-24, 075-12, 075-24, 100-24
AWG 18 to 16		050-05, 075-05, 100-05, 100-12

Over-heating Protection

The over-heating protection function cuts off the output voltage when the temperature in an element increases due to over-heating.

When the over-heating protection function is activated, the product does not work properly. Please resupply power after cooling the product sufficiently.

Output De-rating Curve by Ambient Temperature

■ SPA-030-05, SPA-030-24, SPA-050-24, SPA-075-05, SPA-075-24, SPA-100-05, SPA-100-12, SPA-100-24

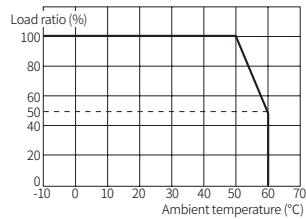

■ SPA-030-12, SPA-050-05, SPA-050-12

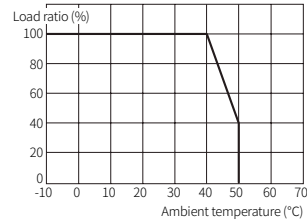

■ SPA-075-12

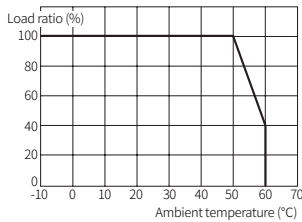

Feature Data of Over-voltage Protection

To protect the connected load, the output is disconnected when the over-voltage is detected.

When the output is disconnected, apply the power after waiting at least 3 minutes.

- Not all models support this function. Check the specification before using.

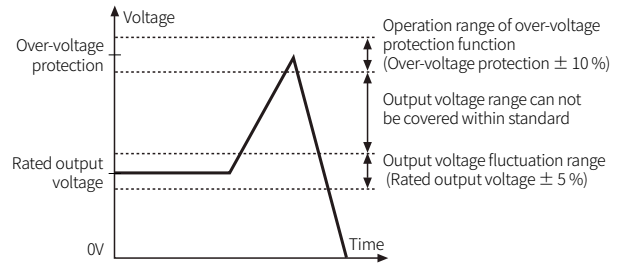

Feature Data of Over-current Protection

When the over rated current is flowed, the over-current protection circuit is operated to protect the product by reducing output voltage.

The protection circuit is released automatically when the load current is under the rated current.

- It is for the rated input voltage 100 VAC~ with 100 % load.

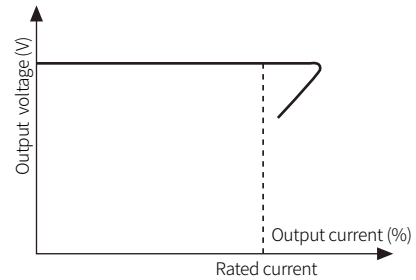

Block Diagram

■ SPA-030 / 050 series

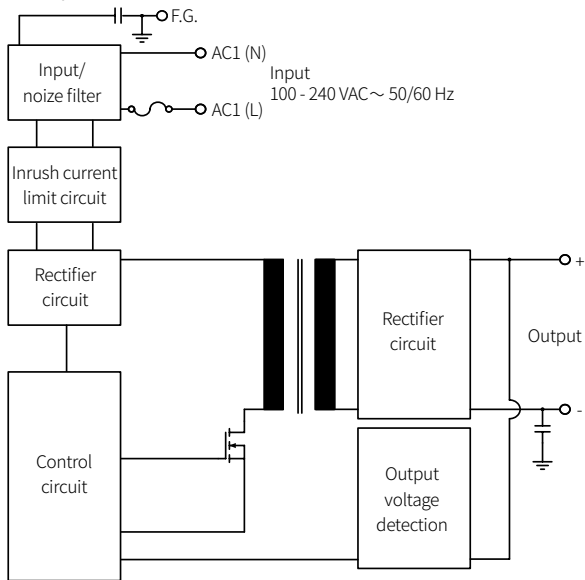

■ SPA-075 / 100 series

