

Ø 16 mm Key Selector Switches



S16KR Series CATALOGPRODUCT MANUAL

For your safety, read and follow the considerations written in the instruction manual, other manuals and Autonics website.

The specifications, dimensions, etc. are subject to change without notice for product improvement. Some models may be discontinued without notice.

Features

- Compact, space-saving 16 mm installation diameter
- Short rear-length size of only 29.5 mm
- Independent detachable contacts

Safety Considerations

- Observe all 'Safety Considerations' for safe and proper operation to avoid hazards.
- ⚠ symbol indicates caution due to special circumstances in which hazards may occur.







⚠ Warning Failure to follow instructions may result in serious injury or death.

- 01. Fail-safe device must be installed when using the unit with machinery that may cause serious injury or substantial economic loss. (e.g. nuclear power control, medical equipment, ships, vehicles, railways, aircraft, combustion apparatus, safety equipment, crime / disaster prevention devices, etc.)**
Failure to follow this instruction may result in personal injury, economic loss or fire.
- 02. Do not use the unit in the place where flammable / explosive / corrosive gas, high humidity, direct sunlight, radiant heat, vibration, impact, or salinity may be present.**
Failure to follow this instruction may result in explosion or fire.
- 03. Install on a device panel to use.**
Failure to follow this instruction may result in fire or electric shock.
- 04. Do not connect, repair, or inspect the unit while connected to a power source.**
Failure to follow this instruction may result in fire or electric shock.
- 05. Do not disassemble or modify the unit.**
Failure to follow this instruction may result in fire or electric shock.





⚠ Caution Failure to follow instructions may result in injury or product damage.





- 01. This unit shall not be used outdoors.**
Failure to follow this instruction may result in shortening the life cycle of the product or electric shock.
- 02. Use the unit within the rated specifications.**
Failure to follow this instruction may result in fire or product damage.
- 03. Do not use the load beyond rated switching capacity contact.**
Failure to follow this instruction may result in fire, relay broken, contact melt, insulation failure or contact failure.
- 04. For wiring the product, do not pull the wiring excessively or apply excessive force.**
Failure to follow this instruction may result in product damage or malfunction.
- 05. Use dry cloth to clean the unit, and do not use water or organic solvent.**
Failure to follow this instruction may result in fire or electric shock.
- 06. Keep the product away from metal chip, dust, and wire residue which from flowing into the unit.**
Failure to follow this instruction may result in fire or product damage.

Specifications

Series	S16KR Series
Actuation angle	2-position: $90^\circ \pm 5^\circ$, 3-position: $45^\circ \pm 5^\circ$
Actuation force	20 to 120 N·mm
Installation	Extended
Shock	500 m/s ² (≈ 30 G) in each X, Y, Z direction for 3 times
Shock (malfunction)	100 m/s ² (≈ 10 G) in each X, Y, Z direction for 3 times
Vibration	1.5 mm double amplitude at frequency of 10 to 55 Hz in each X, Y, Z direction for 2 hours
Vibration (malfunction)	1.5 mm double amplitude at frequency of 10 to 55 Hz in each X, Y, Z direction for 10 minutes
Mechanical life cycle (control unit life cycle)	$\geq 250,000$ operations (20 operations/min)
Ambient temperature	-15 to 55 °C, storage: -25 to 65 °C (no freezing or condensation)
Ambient humidity	35 to 85 %RH, storage: 35 to 85 %RH (no freezing or condensation)
Protection structure	Control unit: IP65 (IEC standard)
Certification	CE ⁰¹ UK      
Control unit weight	Round: ≈ 16 g, Square: ≈ 16.2 g, Rectangular: ≈ 17.1 g
Housing weight	≈ 1.4 g

01) IEC-60947-5-1

Contact blocks	
Power supply / current	250 VAC~ / 3 A
Dielectric strength	Between the charging part and the case : 3,000 VAC~ 50/60 Hz for 1 minute
Insulation resistance	≥ 100 M Ω (500 VDC= megger)
Contact resistance	≤ 50 m Ω (initial)
Electrical life cycle	$\geq 100,000$ operations (20 operations/min)
Contact material	AgNi10
Terminal tensile force	≤ 30 N
Terminal soldering time	At the end of tips within 3 sec with 350 °C (30 W-soldering machine)
Certification	CE     
Weight	≈ 1.6 g

LED blocks	
Rated voltage	5 / 12 / 24 VDC= model
Current consumption	Refer to the below Current consumption table.
Certification	CE    
Weight	≈ 1.9 g

Current consumption	Red	Blue	Green	Yellow	White
SA16-L5 (5 VDC=)	6 to 9 mA	10 to 14 mA	5 to 7 mA	12 to 16 mA	10 to 14 mA
SA16-L12 (12 VDC=)	9 to 14 mA	10 to 15 mA	5 to 9 mA	10 to 16 mA	9 to 14 mA
SA16-L24 (24 VDC=)	15 to 20 mA	20 to 26 mA	16 to 22 mA	27 to 35 mA	23 to 30 mA

Sold Separately

- Contact blocks (SA□-C□□)
- LED blocks (SA□-L□□□)
- Locking handle (SA□-LH)

Assembly / Disassembly

- Assembly order: ①→②→③→④
- Disassembly order: a→b→c→d

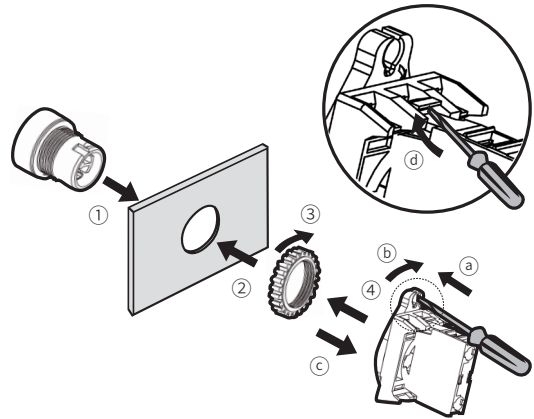

Control Switches	Panel thickness	Tightening torque
Ø 16 mm	Max. 3.5 mm	≤ 0.49 N·m

Key Removal Position

2-position spring return

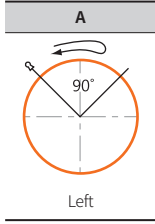

2-position maintained

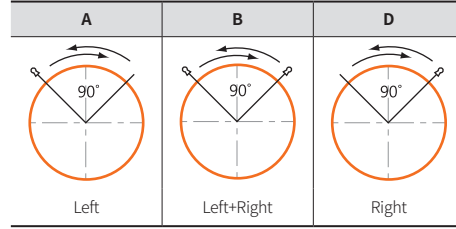

3-position two-way spring return

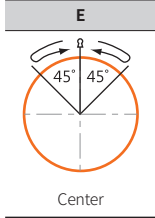

3-position maintained

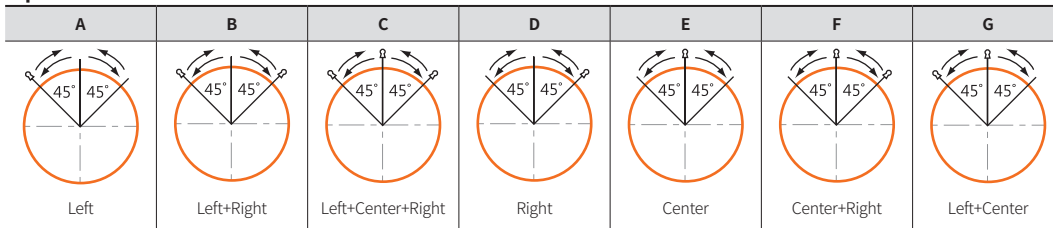

3-position right spring return

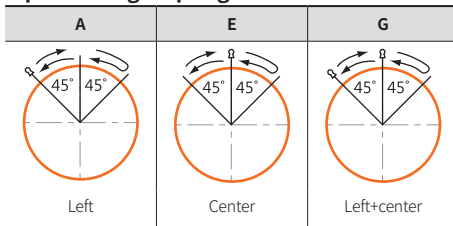

3-position left spring return

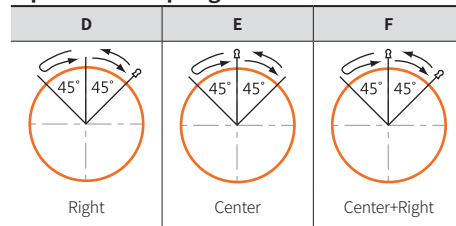

Ordering Information

This is only for reference. For selecting the specified model, follow the Autonics website.

Model is based on control unit+block combination. Control units or blocks are sold separately. In case of block, refer to control switch accessories.

S16	1	2	-	3	4	5	6
Control unit							Block

1 Switch type

KR: Key selector switches (extended)

2 Appearance

No mark: Round

S: Square

T: Rectangular

3 Operation

1: 2-position spring return

2: 2-position maintained

3: 3-position two-way spring return

4: 3-position maintained

5: 3-position right spring return

6: 3-position left spring return

4 Key removal position

Refer to Key Removal Position.

5 Color

K: Black

6 Contact block

C: 1 C contact

2C: 2 C contacts

Model	Contact block	LED block
	C contact	DC voltage
S16KR-1AKC	1	-
S16KR-1AK2C	2	-
S16KR-2AKC	1	-
S16KR-2AK2C	2	-
S16KR-2BKC	1	-
S16KR-2BK2C	2	-
S16KR-2DKC	1	-
S16KR-2DK2C	2	-
S16KR-3EK2C	2	-
S16KR-4AK2C	2	-
S16KR-4BK2C	2	-
S16KR-4CK2C	2	-
S16KR-4DK2C	2	-
S16KR-4EK2C	2	-
S16KR-4FK2C	2	-
S16KR-4GK2C	2	-
S16KR-5AK2C	2	-
S16KR-5EK2C	2	-
S16KR-5GK2C	2	-
S16KR-6DK2C	2	-
S16KR-6EK2C	2	-
S16KR-6FK2C	2	-
S16KRS-1AKC	1	-
S16KRS-1AK2C	2	-
S16KRS-2AKC	1	-
S16KRS-2AK2C	2	-
S16KRS-2BKC	1	-
S16KRS-2BK2C	2	-
S16KRS-2DKC	1	-
S16KRS-2DK2C	2	-
S16KRS-3EK2C	2	-
S16KRS-4AK2C	2	-
S16KRS-4BK2C	2	-
S16KRS-4CK2C	2	-
S16KRS-4DK2C	2	-
S16KRS-4EK2C	2	-
S16KRS-4FK2C	2	-
S16KRS-4GK2C	2	-
S16KRS-5AK2C	2	-
S16KRS-5EK2C	2	-
S16KRS-5GK2C	2	-
S16KRS-6DK2C	2	-
S16KRS-6EK2C	2	-
S16KRS-6FK2C	2	-
S16KRT-1AKC	1	-
S16KRT-1AK2C	2	-
S16KRT-2AKC	1	-
S16KRT-2AK2C	2	-
S16KRT-2BKC	1	-
S16KRT-2BK2C	2	-
S16KRT-2DKC	1	-
S16KRT-2DK2C	2	-
S16KRT-3EK2C	2	-
S16KRT-4AK2C	2	-
S16KRT-4BK2C	2	-
S16KRT-4CK2C	2	-
S16KRT-4DK2C	2	-
S16KRT-4EK2C	2	-
S16KRT-4FK2C	2	-
S16KRT-4GK2C	2	-
S16KRT-5AK2C	2	-
S16KRT-5EK2C	2	-
S16KRT-5GK2C	2	-
S16KRT-6DK2C	2	-
S16KRT-6EK2C	2	-
S16KRT-6FK2C	2	-

Dimensions

- Unit: mm, For the detailed drawings, follow the Autonics website.
- Panel thickness: ≤ 3.5 mm

■ S16KR-□ (round)

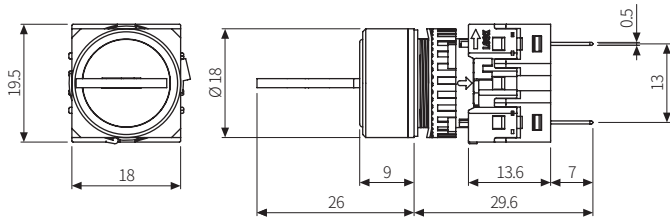

■ S16KRS-□ (square)

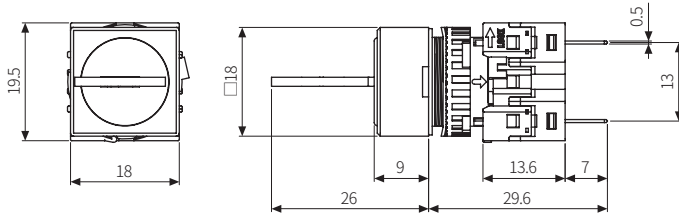

■ S16KRT-□ (rectangular)

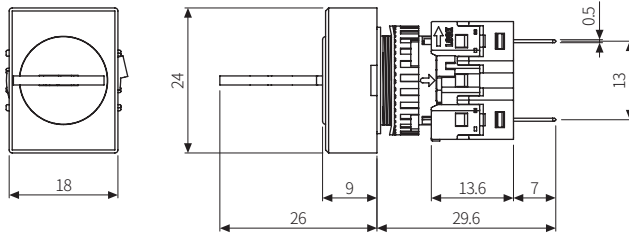

■ Terminal pin

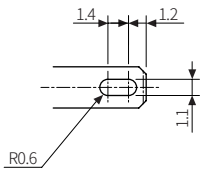

■ Panel cut-out

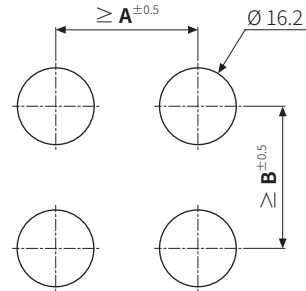

	A	B
Round	20	21
Square	20	21
Rectangular	25	21